

rationel®

# Rationel windows and doors

Beautiful design for  
sustainable living.

# Contents

Our story	3
The right choice for your home	5
Windows	7
AURA and AURAPLUS	8
FORMA and FORMAPLUS	10
Window types and openings	12
Doors	15
Customising your door	16
For your inspiration	18
Door types and openings	20
Glazing options	22
Handles and accessories	23
Secured by Design and Part Q	24
Colour	26

# Our story



From a small workshop in Denmark in 1954, a lone carpenter worked diligently to create his first order of 31 barn windows. He invested the profits in modern machinery and Rationel was born.

More than 60 years later we're still here, shipping 600,000 state-of-the-art windows and doors around the world each year. All of them bespoke, all of them beautiful. We may have grown, but we've maintained our firm focus on quality craftsmanship and service.

Rationel specialises in Scandinavian design. Slim sight lines, high-quality timber and unique ironmongery, along with the flexibility to stand tall, slant or curve to your requirements, mean our windows and doors add something truly special to your home. Our experts will help you find the perfect style to suit your project, whether that's traditional, modern or somewhere in between.

Our doors and windows look good but they perform even better; they're built to last, designed to meet the highest standards of comfort, security and weather-tightness. For your peace of mind, our doors and windows have Secured by Design accreditation, which means they are extremely difficult to break into.

We plan to be crafting windows and doors for homes for generations to come. So we go out of our way to source sustainable materials, whether that's the FSC®-certified trees that go into our frames or the waste timber that fuels our factories. Our cleverly positioned, energy-efficient windows maximise natural light to reduce CO<sub>2</sub> emissions and utility costs.

We make it our mission to provide exceptional service, from initial design support to hassle-free delivery and efficient after-sales care. Our network of local distributors means we're never far away, and for the times we can't talk in person, we're just a phone call, live chat or email away.



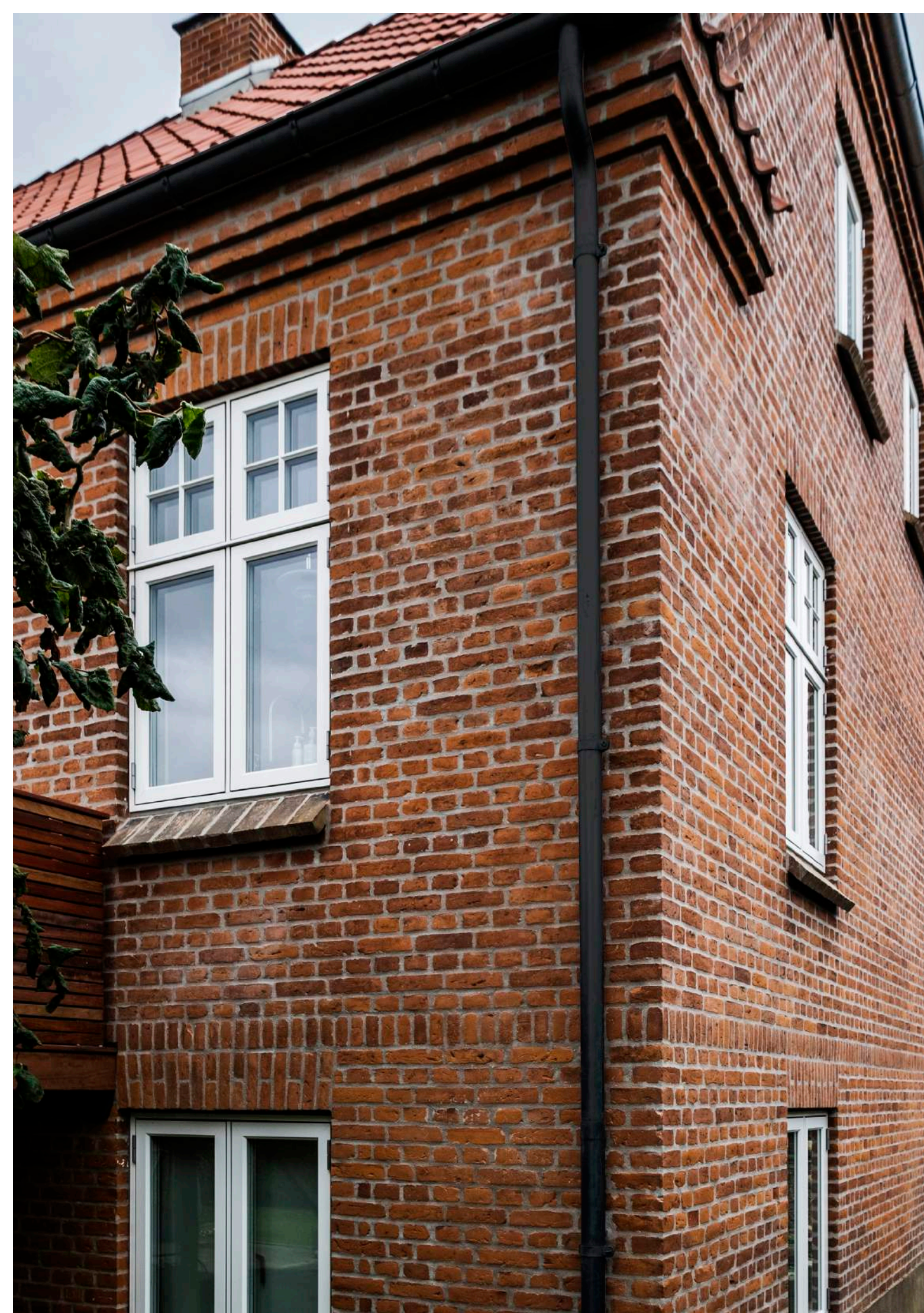

# The right choice for your home

Your door is the gateway to your home; the way it looks and moves influences the building's architectural expression. Your windows set the mood, determining the light and temperature of your environment. Every detail changes how you and your guests feel about your home.

All our products are bespoke, so it's important to carefully consider every aspect – from colour to glazing options to opening and closing functions.

The pages ahead feature our regular style options for your inspiration; we can also manufacture specially shaped units to suit unique spaces. Our experts can help guide your decisions by taking into account the details of your build and the overall impact you are aiming for.

You can visit our website for technical drawings, certification data, videos and more: [www.rationel.co.uk](http://www.rationel.co.uk)



# Windows

Windows can shape your outlook in more ways than one. From the way the light gathers at dawn to the flow of air during a hot summer, every element should complement your lifestyle. Let us introduce our two signature styles, AURA and FORMA. Both are available with double and triple glazing. The PLUS models feature timber frames with aluminium cladding, which opens up a new range of possibilities.

## AURA and AURAPLUS

AURA personifies clean lines. The sleek, flat frame gives your window a flush finish for a truly modern, Scandinavian feel. This is our most popular profile, especially for a stand-out "grand design". Optional glazing bars can increase the architectural elegance of this style. Made from sustainably sourced timber, your windows and doors will last for decades if looked after.

Choose AURAPLUS and we add aluminium cladding to the timber, which means maintenance becomes minimal and life expectancy rises by another 20+ years. The cladding comes in hundreds of colours and gives you the flexibility to have one colour inside your home and another on the outside. It can make a real impact and adds the durability to deal with the harshest of weather.

## FORMA and FORMAPLUS

Designed to complement traditional British architecture, FORMA brings a softer line to your windows and ensures your project blends with its environment. Beautifully styled in sustainable timber that will last for decades, the bevelled edges bring a homely feel. The colour palette is extensive, with the most popular choices shown on page 27; you'll be choosing the same colour inside and out.

Make it FORMAPLUS and the aluminium cladding gives you the option of another colour for the outside of your home – however, it's unlikely you'll want to cover up this beautiful styling. The cladded frame requires minimal maintenance and is extremely durable in all weather conditions. All styles are available with glazing bars, which particularly suit this style of window.



# AURA and AURAPLUS

Our contemporary style



Side opening with fixed lights

Top guided

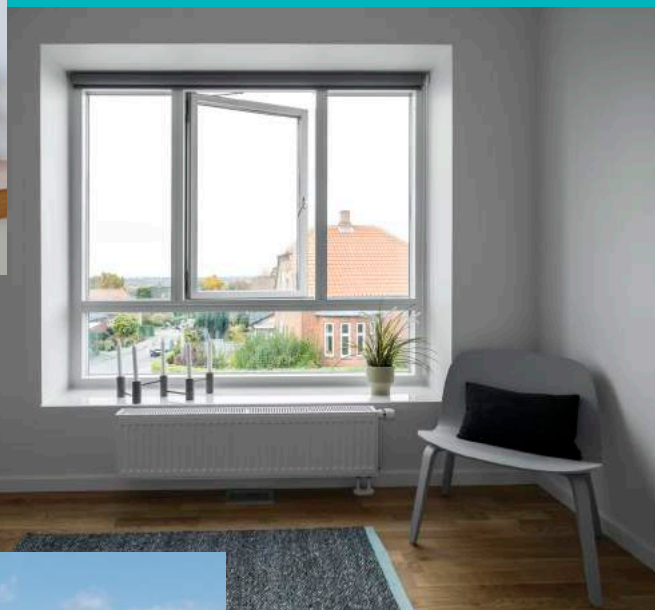

This development used fully reversible windows with coloured opaque glass on the first floor.



Casement door

## AURA

### Key features:

- Timber frame
- 60-year life expectancy\*
- Available in more than 200 colours
- Best performance

### Triple glazed:

- 0.78 W/m<sup>2</sup> K U-value
- 42 dB Rw sound reduction

### Double glazed:

- 1.29 W/m<sup>2</sup> K U-value
- 41 dB Rw sound reduction



## AURAPLUS

### Key features:

- Aluminium-clad timber frame
- Low-maintenance
- 83-year life expectancy\*
- Available in more than 200 colours
- Dual colour no extra charge
- Best performance

### Triple glazed:

- 0.79 W/m<sup>2</sup> K U-value
- 42 dB Rw sound reduction

### Double glazed:

- 1.29 W/m<sup>2</sup> K U-value
- 40 dB Rw sound reduction

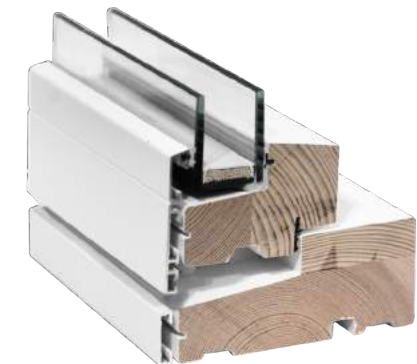

AURA and AURAPLUS come with security hardware as standard to meet Secured by Design requirements. The majority of timber originates from FSC®-certified forests. Read more at [www.rational.co.uk](http://www.rational.co.uk)

\*Dr Gillian Menzies, Institute for Building and Urban Design, Heriot-Watt University, Edinburgh



# FORMA and FORMAPLUS

Our traditional style



Double casement door



Double side hung window with satin glass



This residential development used sideguided windows with horizontal glazing bar



Double patio door

## FORMA

### Key features:

- Timber frame
- 60-year life expectancy\*
- Available in more than 200 colours
- Best performance

### Triple glazed:

- 0.78 W/m<sup>2</sup> K U-value
- 42 dB Rw sound reduction

### Double glazed:

- 1.27 W/m<sup>2</sup> K U-value
- 40 dB Rw sound reduction



## FORMAPLUS

### Key features:

- Aluminium-clad timber frame
- Low-maintenance
- 83-year life expectancy\*
- Available in more than 200 colours
- Dual colour no extra charge
- Best performance

### Triple glazed:

- 0.80 W/m<sup>2</sup> K U-value
- 43 dB Rw sound reduction

### Double glazed:

- 1.28 W/m<sup>2</sup> K U-value
- 40 dB Rw sound reduction

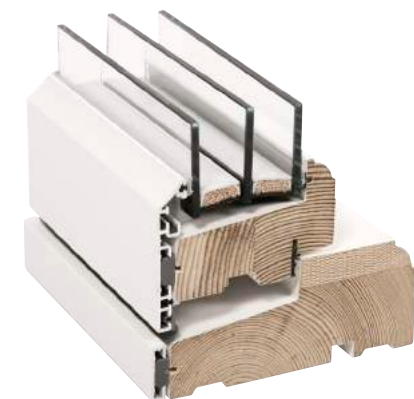
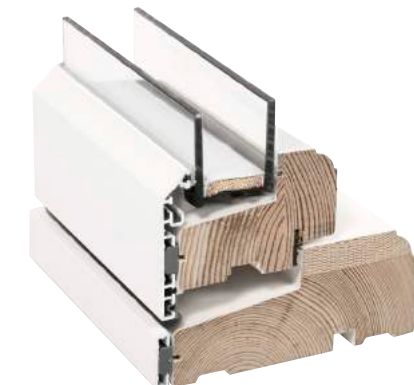

FORMA and FORMAPLUS come with security hardware as standard to meet Secured by Design requirements. The majority of timber originates from FSC®-certified forests. Read more at [www.rational.co.uk](http://www.rational.co.uk)

\*Dr Gillian Menzies, Institute for Building and Urban Design, Heriot-Watt University, Edinburgh

# Window types and openings

Hung, swung or guided: the drawings below show the range of styles available. Contact Rationel for information on different style combinations.

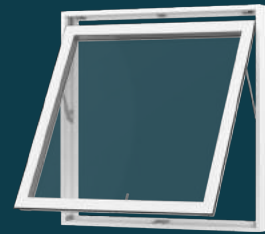

## Top guided

### Opening function

Elegant style that is suitable for all rooms. Simple, seamless opening function allows for effective ventilation when open, both above and below the sash. Clean look with no visible external hinges.

### Measurements

Min. width	358mm
Min. height	383mm
Max. width	1,798mm
Max. height	1,598mm

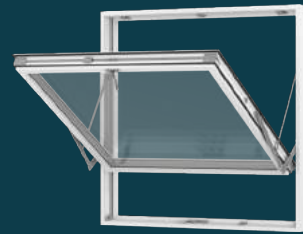

## Fully reversible

### Opening function

Multi-functional style suitable for multi-storey buildings. Sash can be turned to clean the glass from the inside. Comes with a child-proof opening limiter.

### Measurements

Min. width	553mm
Min. height	548mm
Max. width	1,598mm
Max. height	1,598mm



## Fixed light

### Opening function

Simple style that allows for optimal views. Ideal when you need maximum internal light and solar heat. Can be fitted with trickle-vents for ventilation.

### Measurements

Min. width	253mm
Min. height	253mm
Max. width	2,998mm
Max. height	2,998mm



## Side hung

### Opening function

Simple, stylish design with a seamless opening function. On larger windows, the friction brake allows the window to be fixed in any open position. Suitable as escape windows.

### Measurements

Min. width	353mm
Min. height	358mm
Max. width	948mm
Max. height	1,798mm



## Side guided

### Opening function

Minimalist design that moves seamlessly, with no visible external hinges. When fully open the glass can be cleaned from the inside.

### Measurements

Min. width	453mm
Min. height	438mm
Max. width	998mm
Max. height	1,798mm

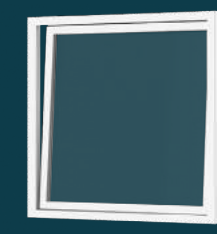

## Tilt and turn

### Opening function

Multi-functional style suitable for multi-storey buildings. Tilt function opens the top of the sash inwards for ventilation. Can be cleaned from the inside, and are perfectly suited as "escape windows" or emergency exits.

Available in AURAPLUS triple glazed only.

### Measurements

Min. width	478mm
Min. height	438mm
Max. width	1,298mm
Max. height	1,598mm

All maximum width and height measurements are subject to glass weight and specification.





# Doors

Make a grand entrance with a bold front door or bring fluidity to your space with sliding patio doors; a great door will change the way you live. Browse the styles, colours, materials and security features we offer in the following pages.



# Customising your door

The following illustrations are examples of door and vision panel styles that can be matched.

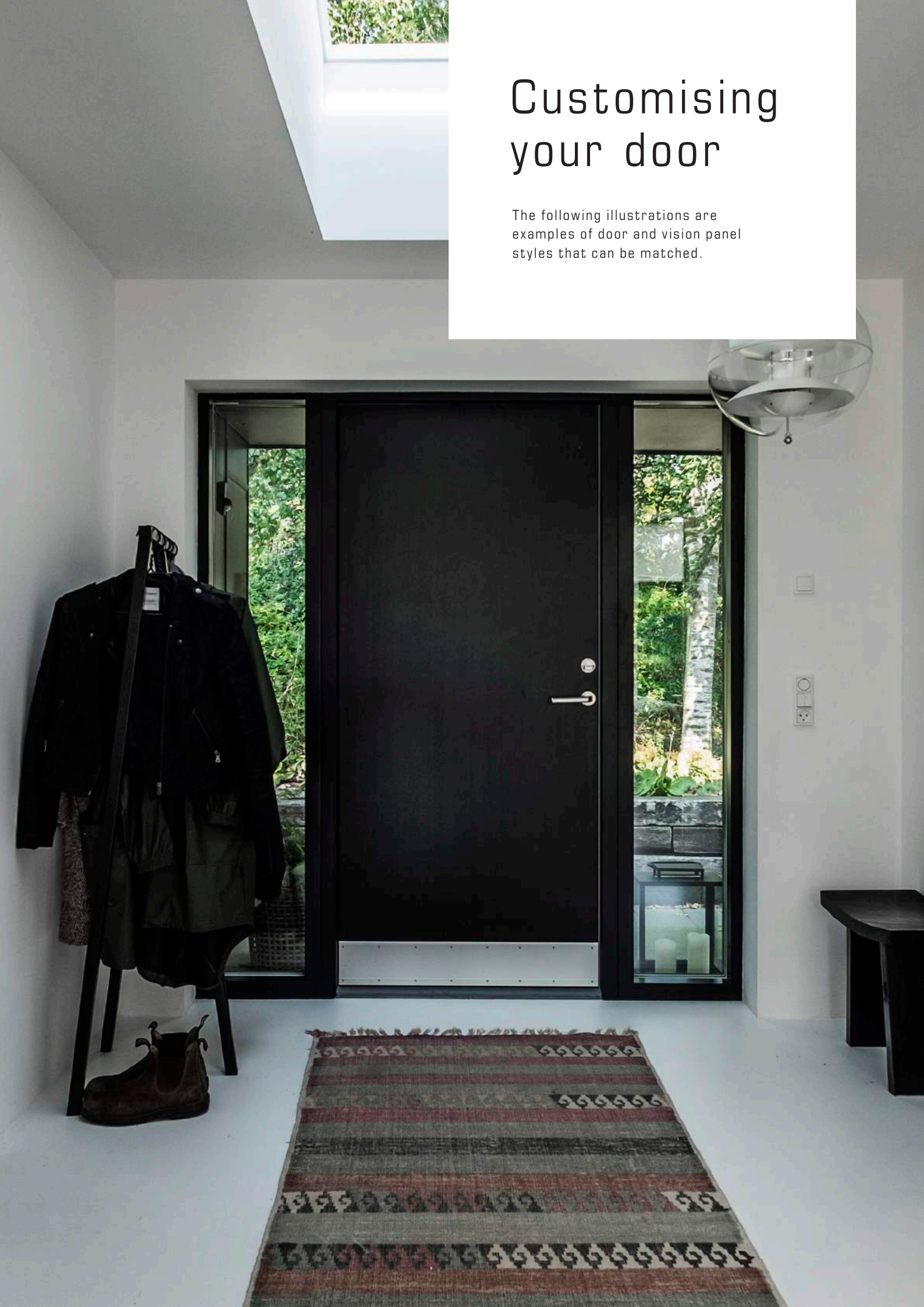

## Flush entrance doors



Flush entrance doors can be customised, with several options to mix and match your preferred door with vision panel style and position.



Plain



Vertical



Diagonal



Herringbone



Oval



Antique

## Window types



Oval



Farmhouse



Rectangle



Square



Circle



Diamond

## Glazed entrance doors and patio doors



Glazed entrance doors can also be customised. We can recommend standard options or work with you to create any variation you require.



Glazed door

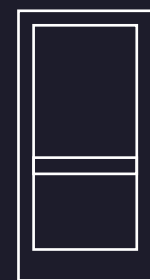

Glazed door with single glazing bar



Glazed door with two glazing bars



Multi-light glazing door



Multi-light glazing door



Multi-light glazing door



# For your inspiration



01

Glazed entrance door



02

Glazed entrance door



03

Flush entrance door



04

Flush entrance door



05

Flush entrance door with integrated sidelight



06

Flush entrance door with integrated sidelight



07

Flush entrance door with sidelight



08

Glazed entrance door with integrated sidelight

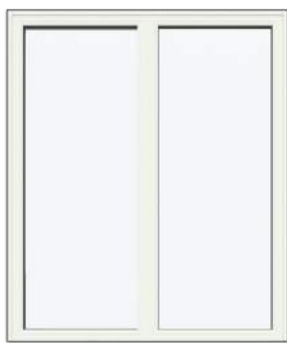

09

Double casement door



10

Sliding door  
Only available in AURAPLUS triple-glazed only

## Your choice

Contact us for more options, we can help you design the perfect door for your project.





# Door types and openings

Tilt, turn or slide: the drawings below show the range of styles available.  
Contact Rational for information about more options and style combinations.



## Flush entrance door

### Features

Available as inward- or outward-opening, flush doors are hung on grey powder-coated adjustable hinges and fitted with a minimum three-point locking espagnolette bolt.

Flush doors can be manufactured with a wide range of patterns and vision panels. See examples on page 17.

### Measurements

Min. width	653mm
Min. height	1,703mm
Max. width	1,198mm
Max. height	2,398mm



## Glazed entrance door

### Features

Available as inward- or outward-opening, glazed entrance doors are hung on grey powder-coated adjustable hinges and fitted with a multipoint lock box with latch deadbolt locking espagnolette bolt.

Glazed entrance doors are constructed using a frame and sash with an option of glazing bars, transoms and mullions. The glass can be composite or insulated panel.

### Measurements

Min. width	653mm
Min. height	1,703mm
Max. width	1,198mm
Max. height	2,498mm



## Patio door

### Features

Available as either inward- or outward-opening, patio doors are ideal for access to balconies, gardens and patios.

Doors have an inbuilt friction brake\*, operated by turning the handle down in any given position. They are hung on grey powder-coated adjustable hinges and fitted with a minimum three-point locking espagnolette bolt.

\*Available on master door leaf only.

### Measurements

Min. width	1,188mm
Min. height	1,703mm
Max. width	2,328mm
Max. height	2,498mm



## Tilt and turn door

### Features

Available as inward-opening only, tilt and turn doors function in two ways. They are hinged from the side and open inwards, or, for ventilation, the leaf can be tilted. Tilt is available on master leaf only.

Available in Rational AURAPLUS triple-glazed only.

### Measurements

Min. width	1,003mm
Min. height	1,803mm
Max. width	1,998mm
Max. height	2,198mm



## Casement door

### Features

Available as outward-opening only, casement doors are ideal for access to balconies, gardens and patios. The slim construction allows maximum daylight and heat into the house without compromising functionality and comfort.

Casement doors come fitted with an inbuilt friction brake operated by turning the handle down in any given position. They are hung on grey powder-coated adjustable hinges and fitted with a minimum three-point locking espagnolette bolt.

### Measurements

Min. width	938mm
Min. height	1,703mm
Max. width	2,328mm
Max. height	2,398mm



## Sliding door

### Features

Designed to be as beautiful as the views they frame, sliding doors allow the garden into your home in the summer but keep the heat inside throughout the winter.

Sliding doors, where one half slides and the other is fixed, are ideal when space is at a premium. The sliding part lifts easily and glides in front of the fixed section to create a clear opening of up to 1.55 metres.

Available in AURAPLUS triple-glazed only.

### Measurements

Min. width	1,788mm
Min. height	1,863mm
Max. width	3,588mm
Max. height	2,388mm

All maximum width and height measurements are subject to glass weight and specification.



# Glazing options

Rational windows combine safety, privacy and energy-efficiency features that help you make the very best of your home.



**Rational SECURE**  
Our windows are built with security in mind. Read more about our Secured by Design certification on page 24 or watch the video on our website.



**Rational OBSCURE**  
Our panes are designed to restrict the view into private areas such as bathrooms. Choose from six different types of glass to get the combination of light and privacy you desire.



**Rational SAFETY**  
Our glass holds together when shattered, reducing the risk of injury if someone falls into the pane. The toughened glass is designed to fall out of the sash and shatter into small, harmless pieces. Panes can be made of toughened glass, laminated glass or a combination of both.



**Rational FACADE**  
Used in buildings either to create a visually coherent facade or for special colour effects, FACADE is well suited to storey divisions as well as ventilated and insulated panels, and is available in special colours on request.



**Rational SOUND**  
If your home is subject to environmental noise, our noise-reducing panes are for you. Panes feature two glass sheets that act as a break, dramatically reducing the movement of sound into your home and creating a peaceful environment.



**Rational SOLAR**  
Our solar panes limit the amount of sunlight and heat coming into a building, depending on the light and heat shielding levels required. This means significantly less energy will be required to cool hot rooms.

## Durability tests

All our windows are tested for durability. A series of videos are available to view on the Rational website.



Air permeability  
600Pa



Wind resistance  
1600Pa

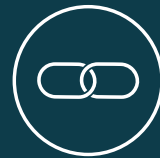

Operation  
10.000 cycles



Water tightness  
600Pa

# Handles and accessories

Customise your windows and doors with different handles and accessories.



Handle for outward opening window and patio door



Handle with child lock



Handle with lockable child safety lock



Entrance door handle with round rose key thumb turn

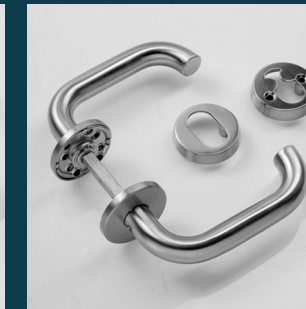

Entrance door handle with round rose key-key

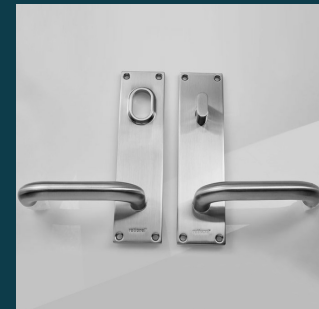

Entrance door handle with back plate key thumb turn



Entrance door handle with back plate key-key



Patio door handle with key internal only



Sliding door finger pull



Sliding door handle

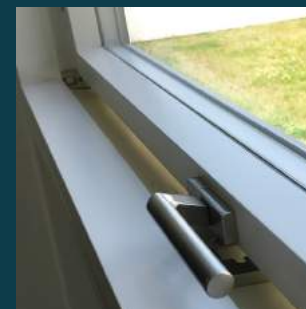

Night vent position



Restrictor



Secured by Design letterplate



Normal letter plate



# Secured by Design and Part Q



Our experience working with housing associations, community developments and commercial projects means the security and safety of our doors are second to none.

Our doors are tested and marked according to several national and European standards, including Secured by Design. That means the frame, lock and hardware can withstand common burglary methods.

To meet Part Q requirements, windows and doors must satisfy particular standards of robustness, use approved hardware and demonstrate proven security performance.

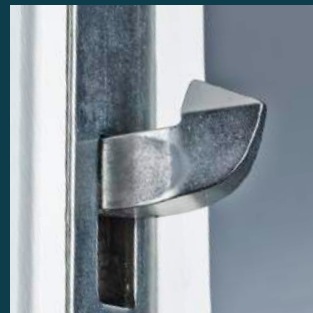

Three-point espagnolette locking mechanism inhibits burglary.



Reinforced espagnolette increases the strength of all closing points.



Extra-strong reinforced screws increase the strength of all hinges.

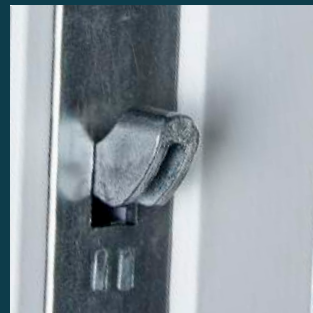

Hook bolts in hardened steel combined with a reinforced front plate resist even severe attacks.



The length of time it takes to break a laminated pane will discourage even the most persistent burglar.



The letterbox has an inner protective housing with a unique concealed hinge mechanism. This limits the opening of the inner flap for maximum protection from "fishing" burglaries.





# Colour

Make a statement or play it cool with your choice of colour. Our standard colours suit most architectural styles, while our special range is ideal for highlighting unique features.

Our windows and doors are available in one standard colour all over. AURAPLUS and FORMAPLUS windows can also be ordered with a different colour inside to outside, with no additional cost.



## Standard colours

If you can't see the colour you want here, you can choose from the whole RAL classic colour chart. Non-standard colours be subject to additional costs and lead times.

Colours shown are indicative only.

Our most popular RAL colours are:

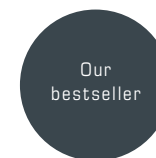

Anthracite grey  
RAL 7016

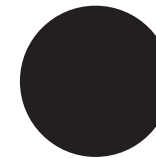

Black  
RAL 9005



White  
RAL 9010



White  
RAL 9010



Cream white  
RAL 9001



Light grey  
RAL 7035

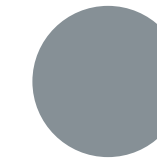

Silver grey  
RAL 7001

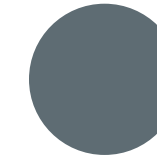

Slate grey  
RAL 7015

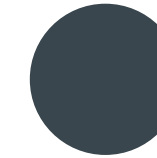

Anthracite grey  
RAL 7016

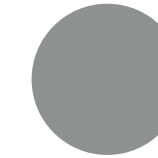

Mid grey  
RAL 7042

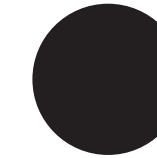

Black  
RAL 9005

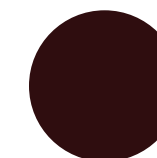

Dark brown  
RAL 8017



Olive green  
RAL 6003



Navy blue  
RAL 5013

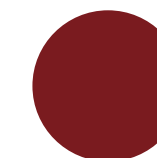

Rowanberry  
RAL 3011

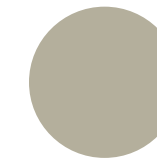

Pebble grey  
RAL 7032

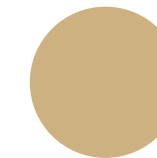

Beige  
RAL 1001

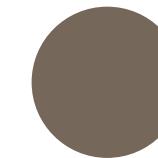

Beige grey  
RAL 7006

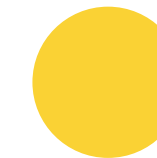

Yellow  
RAL 1018

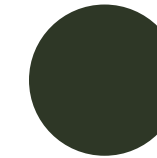

Dark green  
RAL 6007

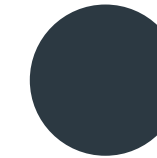

Blue black  
RAL 5008

## Granite

Available for external AURAPLUS and FORMAPLUS windows and doors only.

Colours shown are indicative only.



Granite 01  
White (SAA10F)

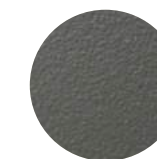

Granite 10  
Light grey (S2150)



Granite 20  
Medium grey (S2400)



Granite 30  
Warm grey (S2900)



Granite 60  
Dark grey (S2100)



Granite 80  
Black (S900)







# Turn your dream home into a design reality

Rationel is part of the VKR Group, whose mission is to establish model companies that create products useful to society and treat customers, suppliers, employees and shareholders better than most other companies.

At the heart of the organisation is a set of Charitable Foundations created to assist employees and their local communities, as well as fund a wide range of environmental, cultural and social programmes.

[www.rationel.co.uk](http://www.rationel.co.uk)  
[quotation@rationel.co.uk](mailto:quotation@rationel.co.uk)  
01869 248 181

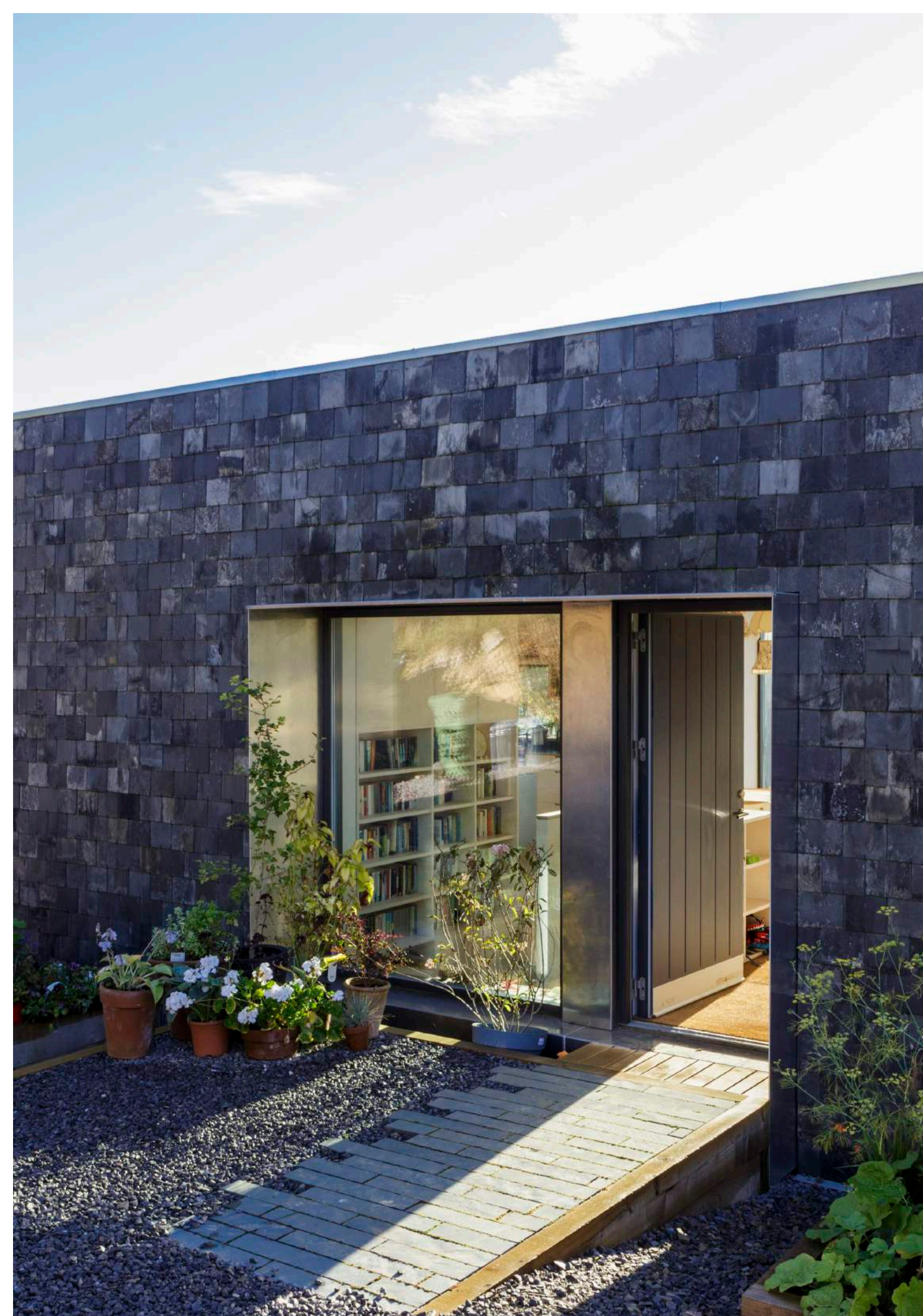



## Contact Rationel

Phone: +44 1869 248 181

Email enquiries: [generalenquiry@rationel.co.uk](mailto:generalenquiry@rationel.co.uk)

LiveChat: visit our website [rationel.co.uk](http://rationel.co.uk)

Rationel Windows Ltd.

7 Avonbury Business Park

Bicester, OX26 2UA



The mark of  
responsible forestry

Secured by Design



Official Police Security Initiative



7000\_03-19\_VI © 2019 Rationel Vinduer A/S ® rationel and rationel logo, Rationel AURA and Rationel AURAPLUS logos are registered trademarks used under licence by Rationel Vinduer A/S. Rationel is not responsible for misprints and reserves the right to make technical changes.

All images are for inspiration only and are subject to change.